







1

<b>A1</b>  7x34	<b>A2</b>  8 Ø15x12 28	<b>C1</b>  8x35 20
---	--	--

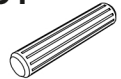
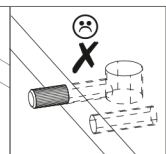
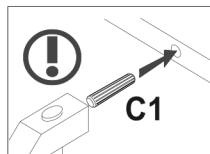
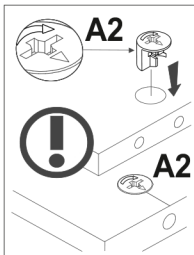
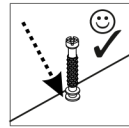
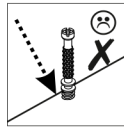
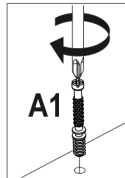
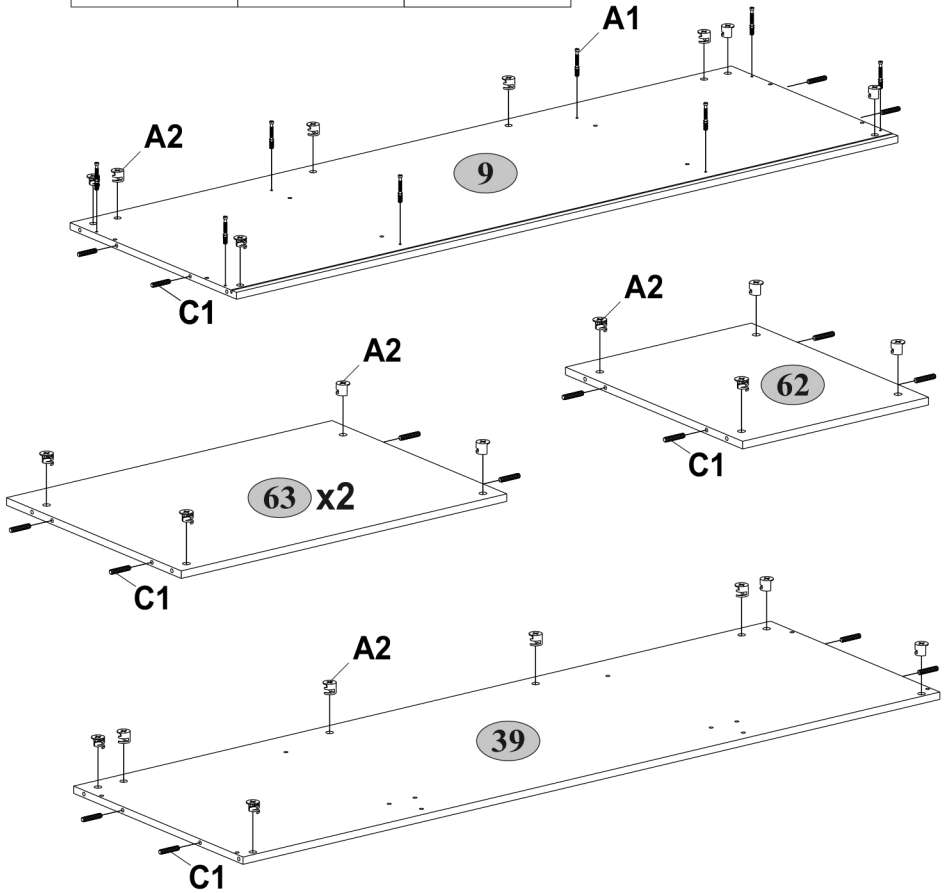



**2**

**A1**  
  
7x34    2

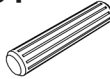
**A2**  
  
Ø15x12    12

**C1**  
  
8x35    8

**P5**  
  
8

**R102**  
  
3,5x16    2

**Y1**  
  
1

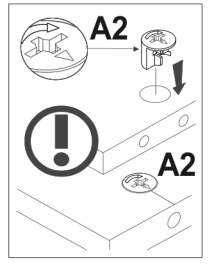
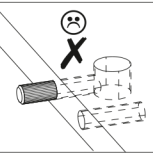
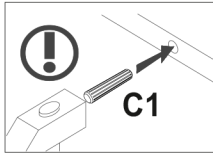
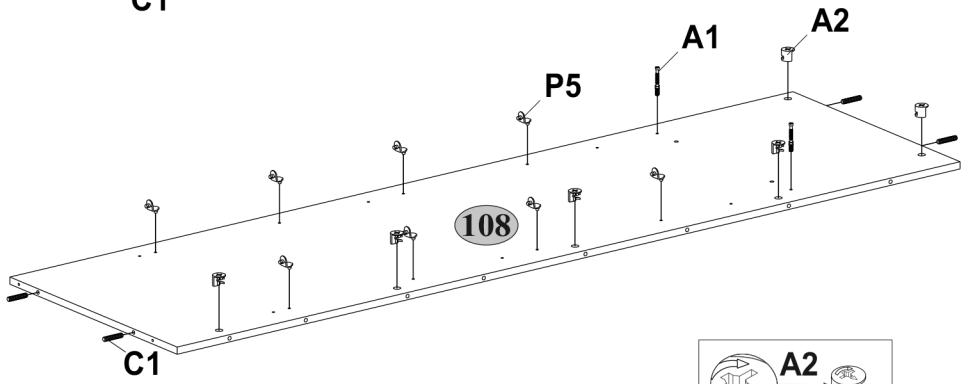
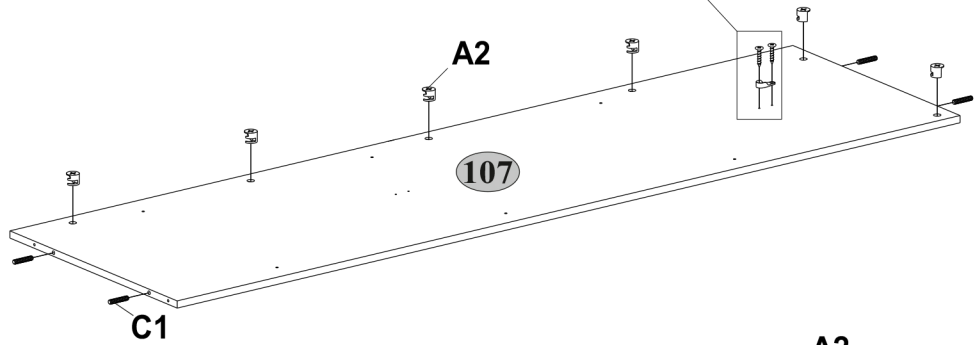
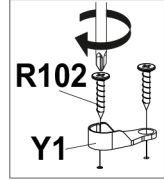
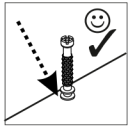
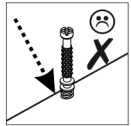
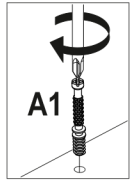

3

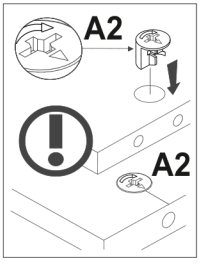
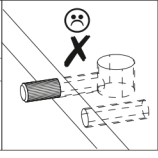
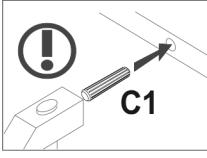
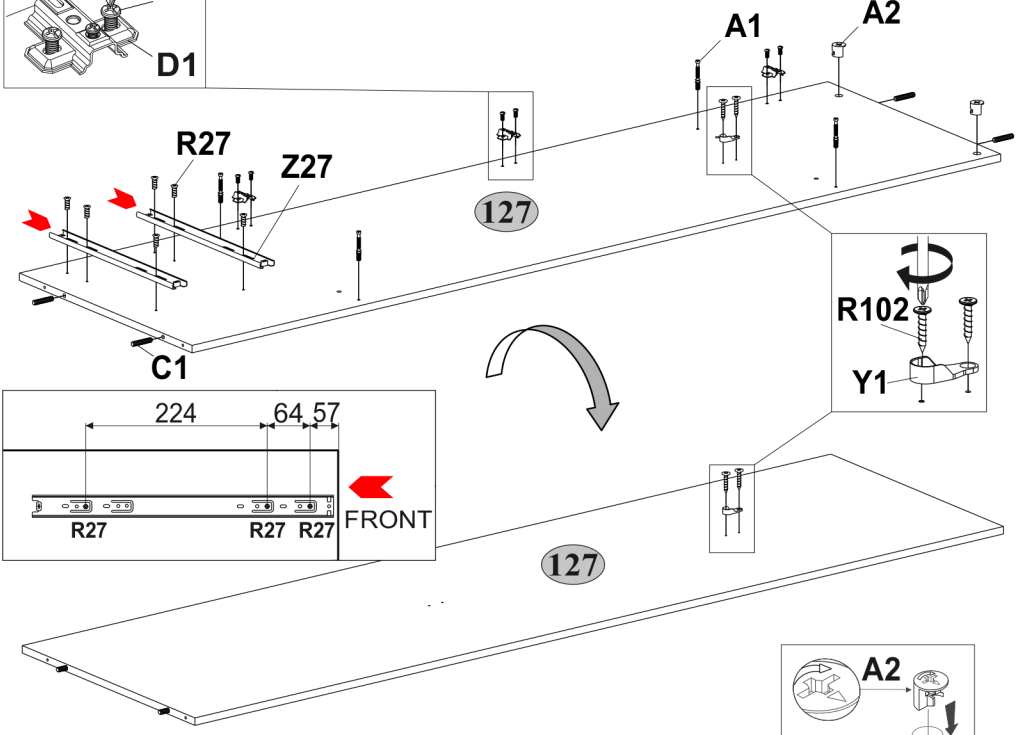
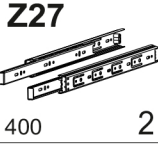
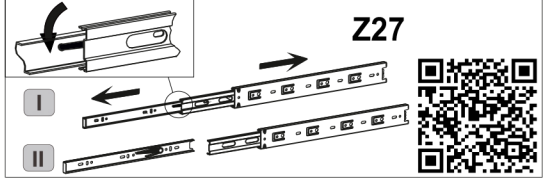
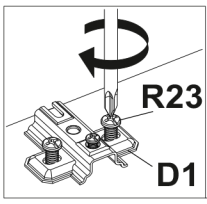
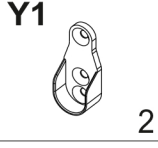
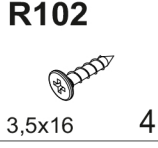
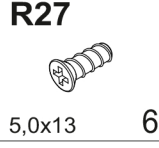
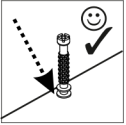
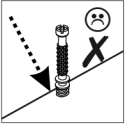
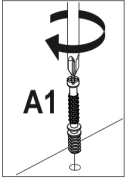
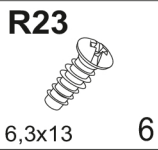
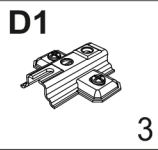
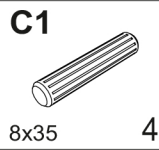
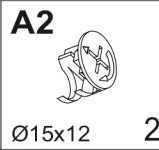
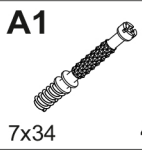

**4****A1**

7x34

**A2**

Ø15x12

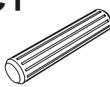
**C1**

8x35

**D1**

3

**P5**

8

**R23**

6,3x13

**R27**

5,0x13

**R102**

3,5x16

**Y1****Z27**

1 400

2

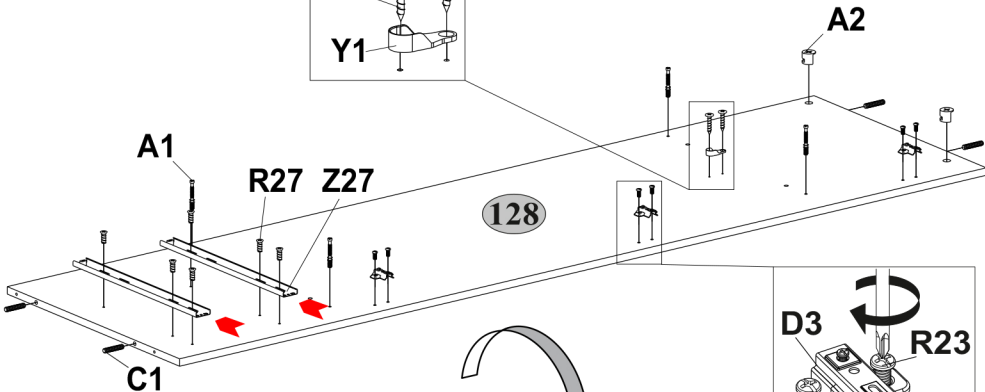
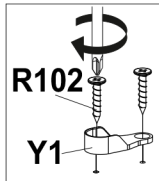
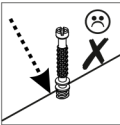
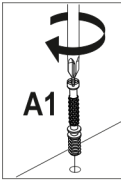
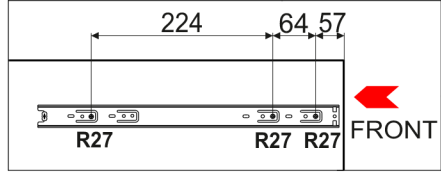
**128**

224

64

57

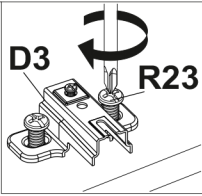
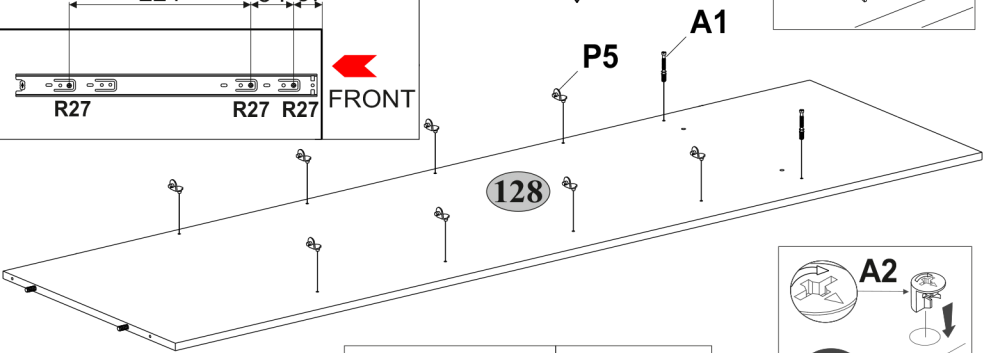
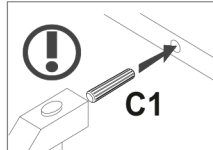
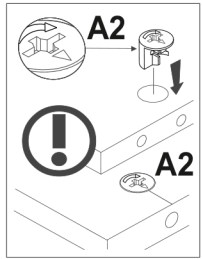
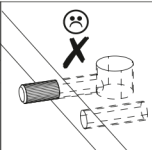
**FRONT****D3****R23****128****C1****A2****A2**

5

A1



7x34

A2



8

Ø15x12

2

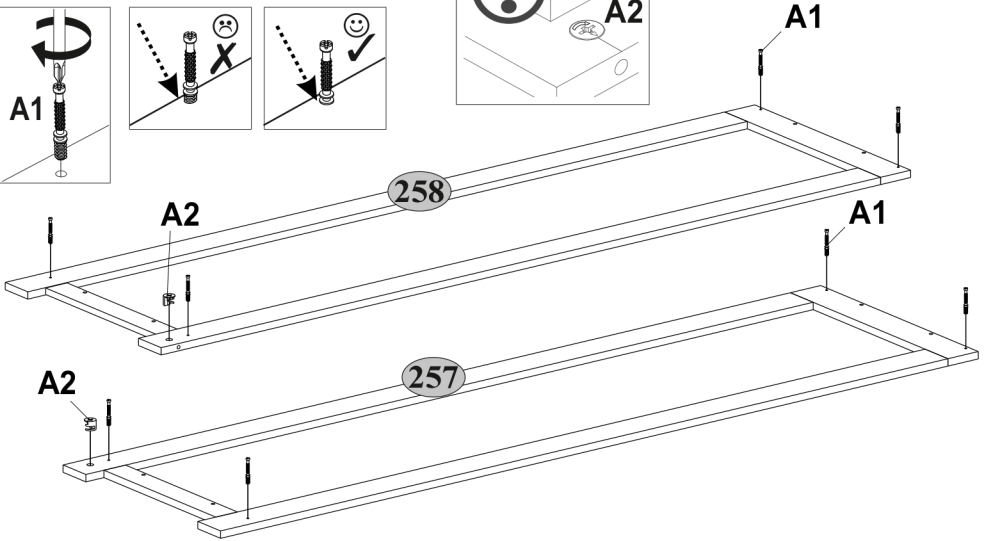
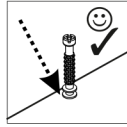
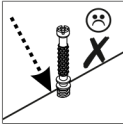
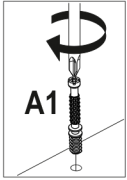
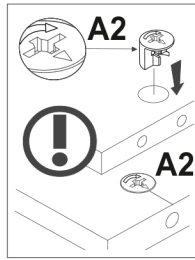

6

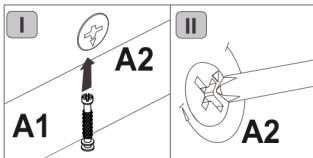
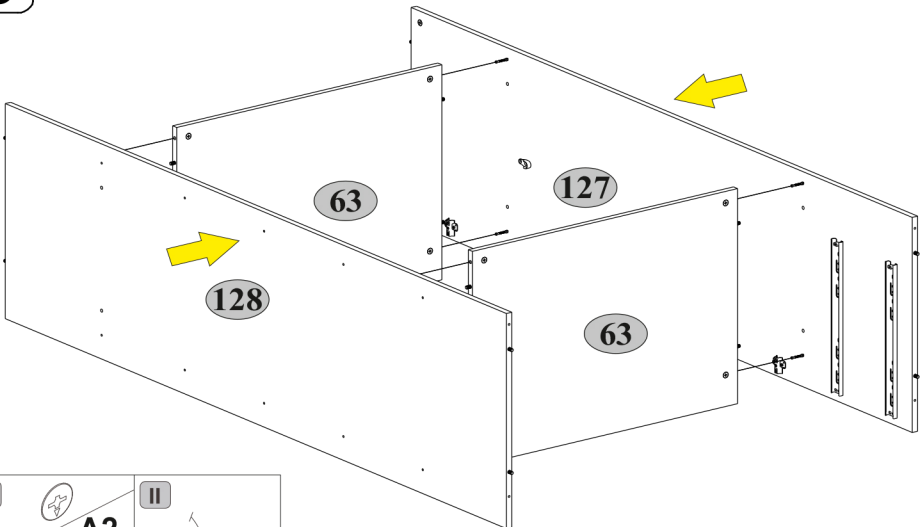

7

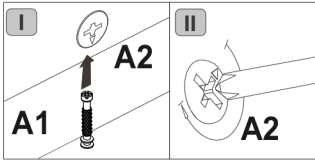
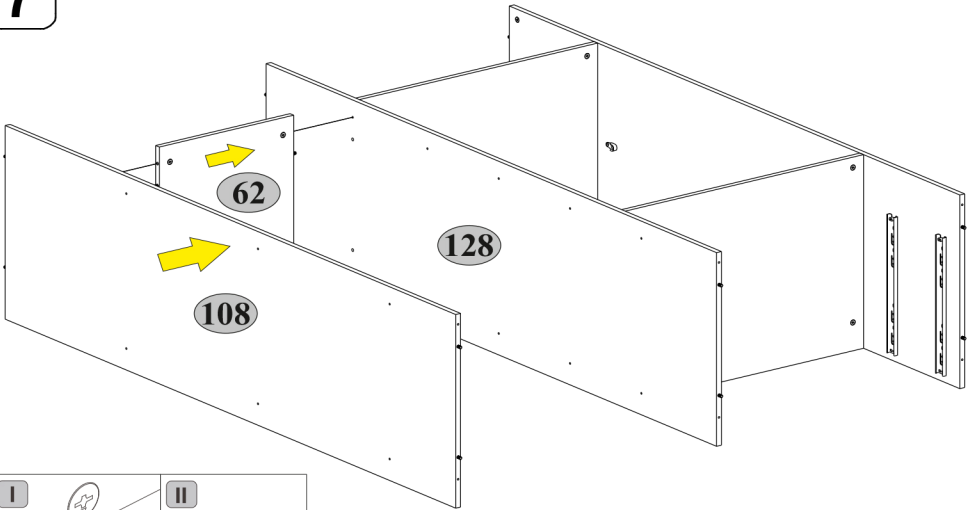

8

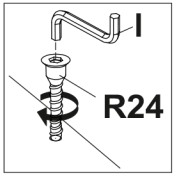
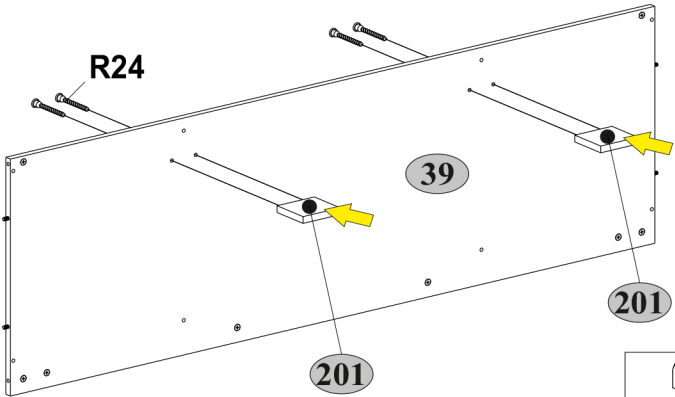
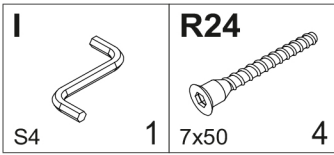

**9**

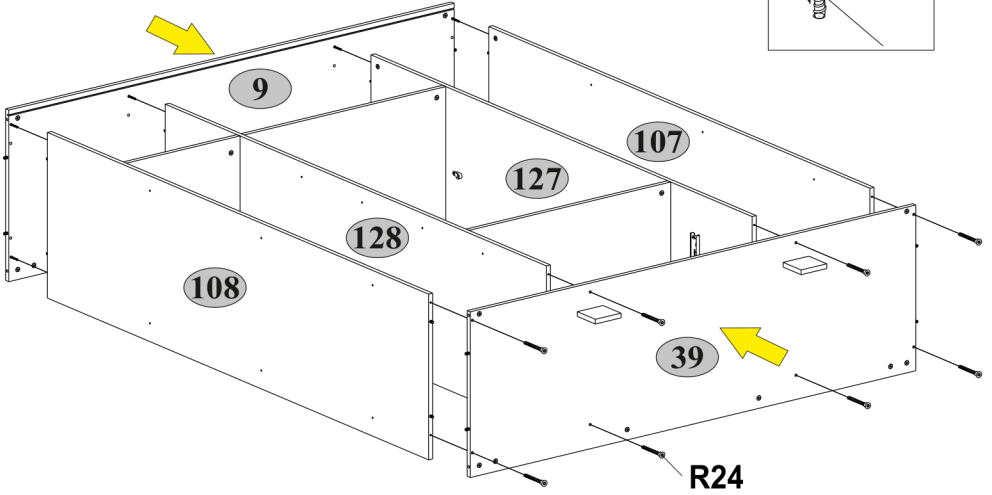
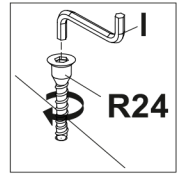
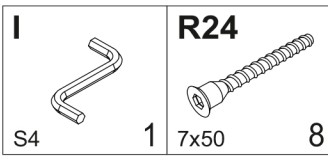

**10**

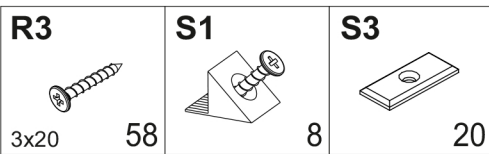

**I**

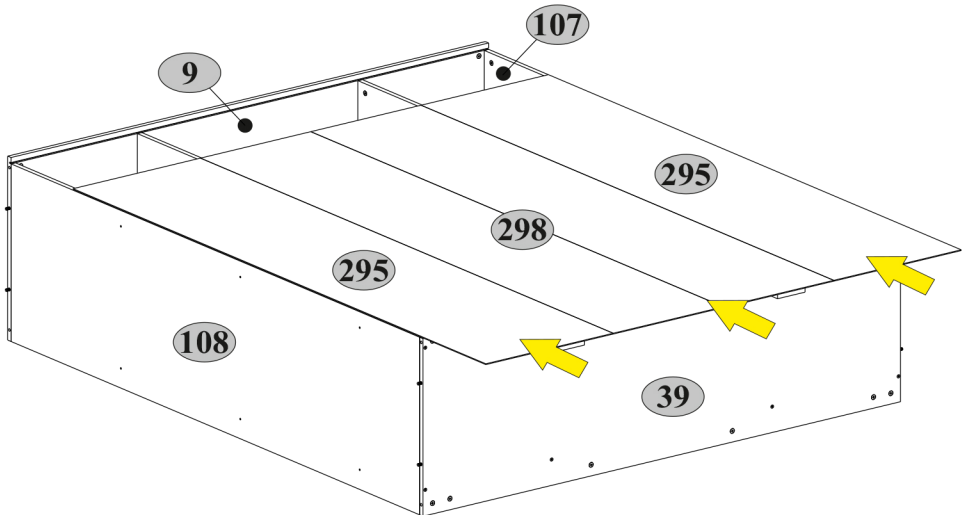





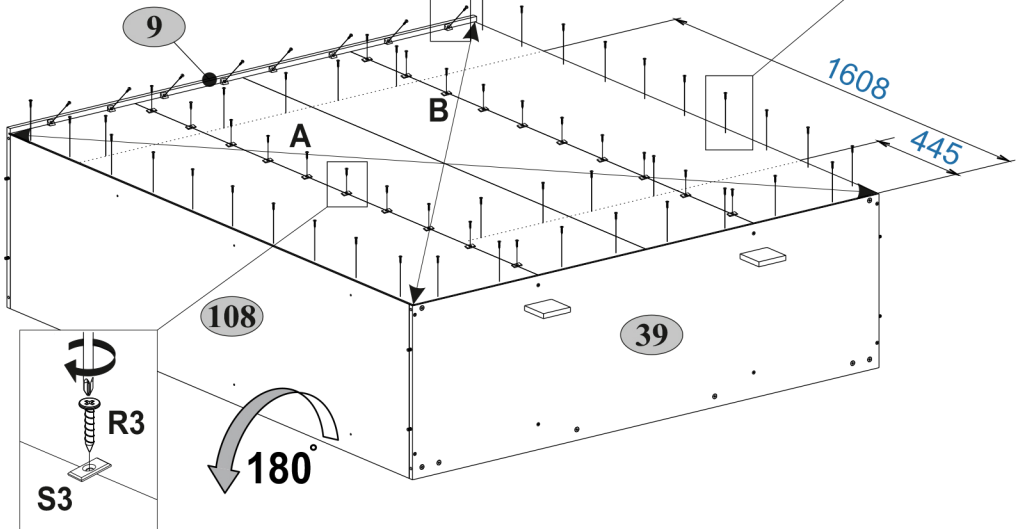
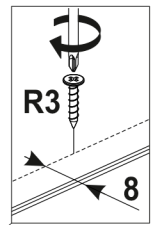
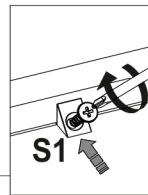
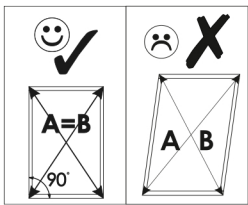

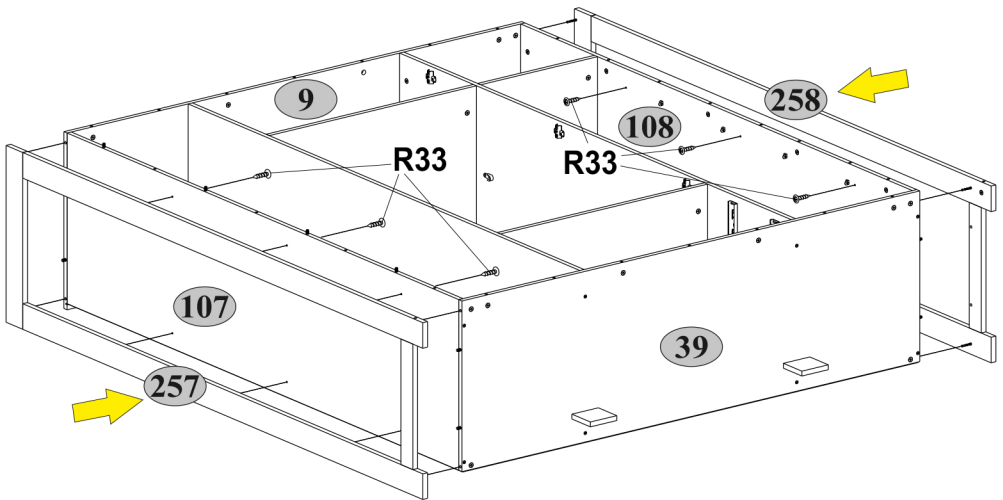
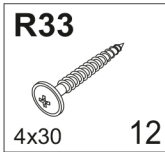

11



11



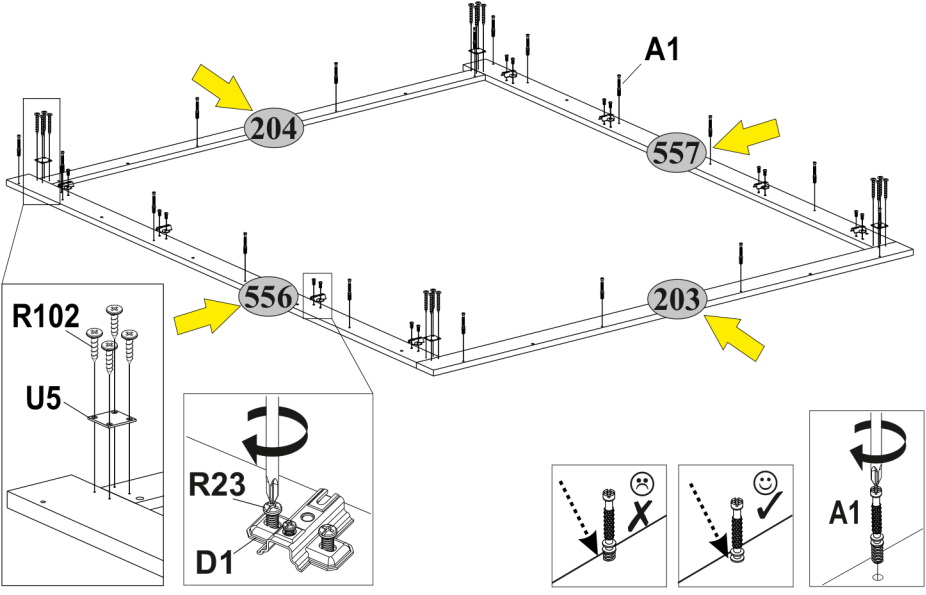

**12**

<b>A1</b>  7x34 18	<b>D1</b>  8	<b>R23</b>  6,3x13 16	<b>R102</b>  3,5x16 16	<b>U5</b>  36x36 4
--	--	---	---	--

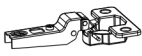

**13**

<b>E4</b>  6	<b>R102</b>  3,5x16 16	<b>H32</b>  2
---	---	--

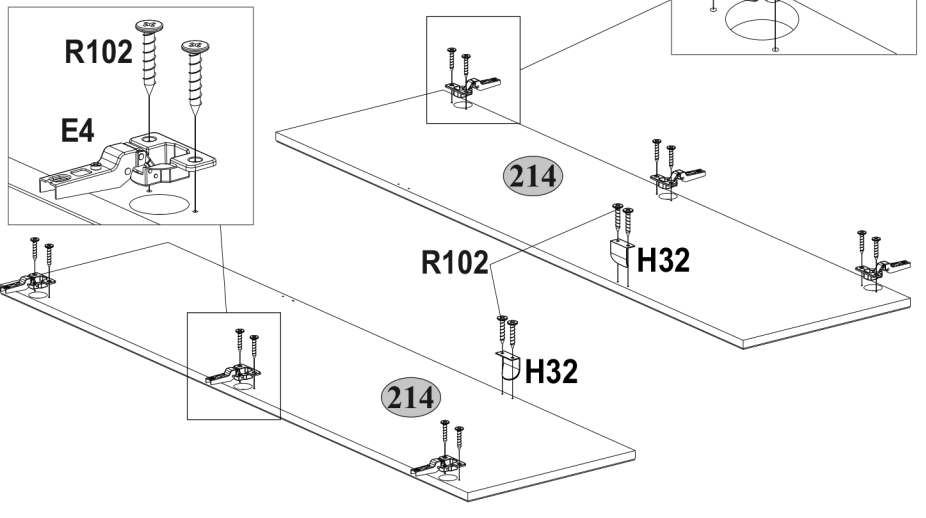

**14**

x2

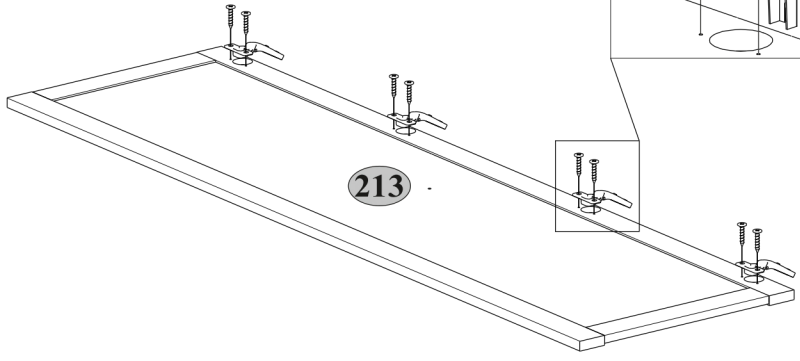
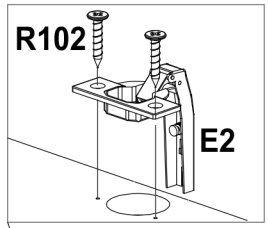
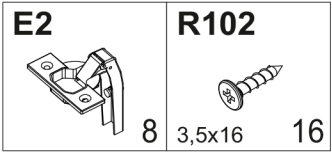

**15**

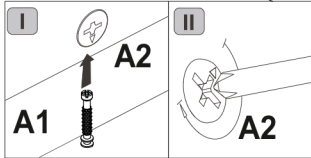
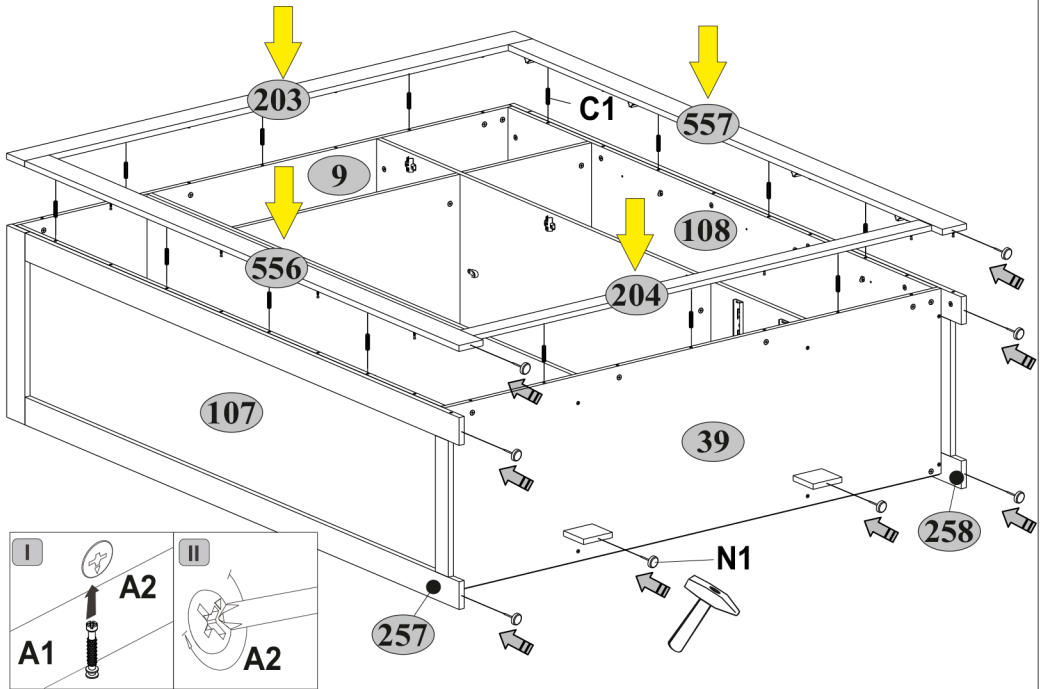
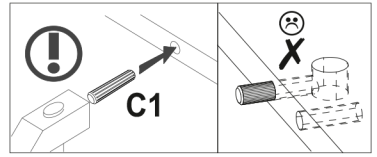
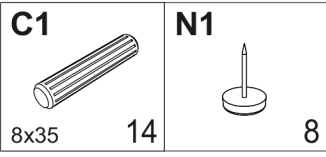

**16****x2****A1**

7x34

8

**A2**

Ø15x12

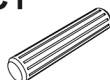
**C1**

8x35

8

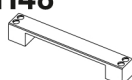
**H48**

2

**I**

S4

1

**M5**

M4x25

4

**R24**

7x50

8

**R27**

5,0x13

12



**Z27**

400

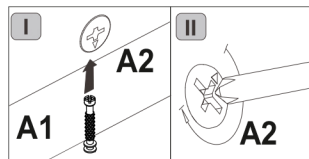
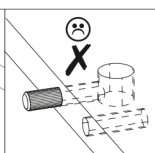
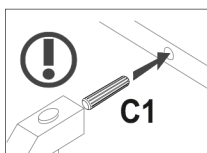
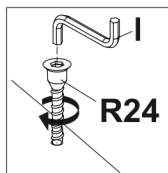
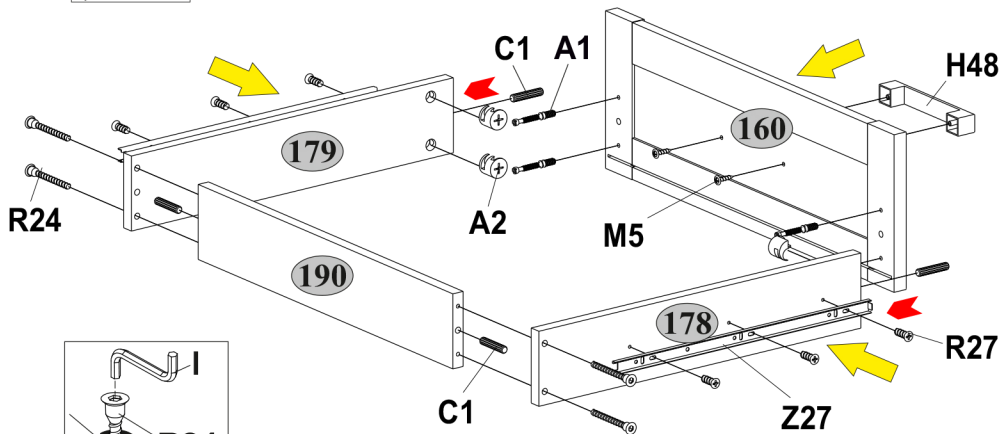
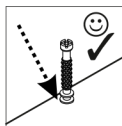
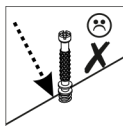
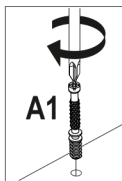
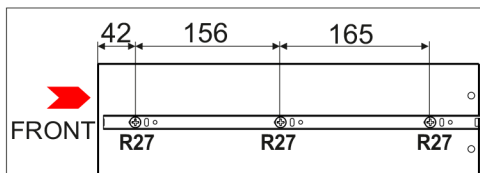
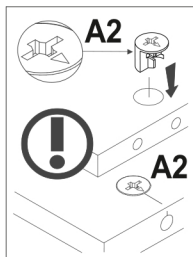
2





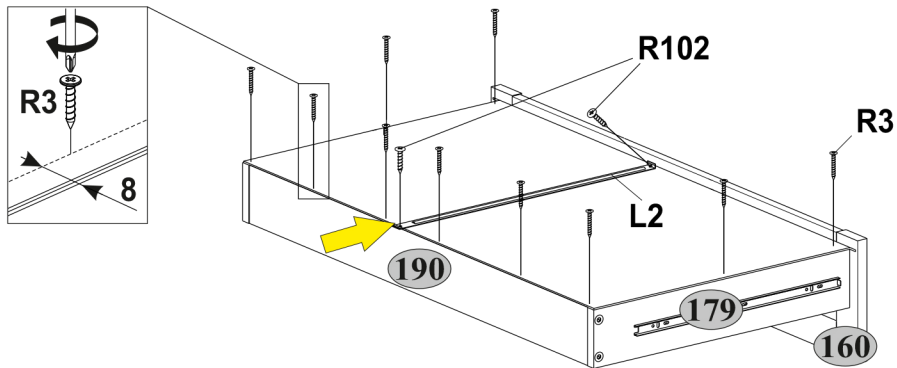
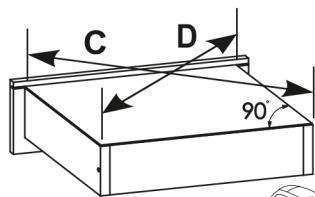

**17****x2**

<b>R3</b>  3x20	<b>L2</b>  500	<b>R102</b>  3,5x16
20	2	4



18

<b>B5</b>  10x50    2	<b>R102</b>  3,5x16    4	<b>S5</b>  Ø18    40	<b>S8</b>  Ø14    2	<b>U.1</b>  45x35x15    2
---	---	--	--	---

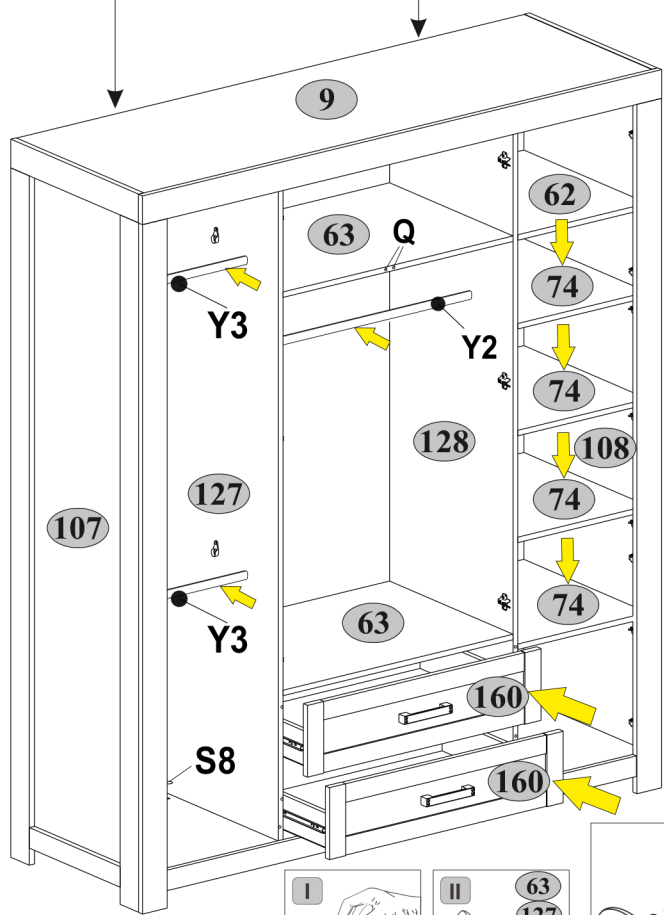
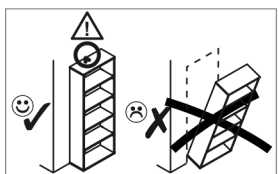
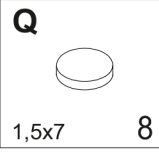
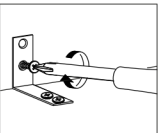
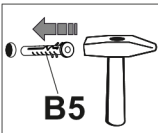
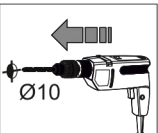
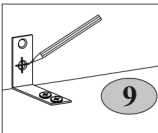
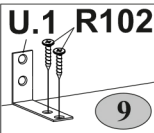

 max. 5 kg

Y2
62
63
74
160

 max. 10 kg

Y3
----

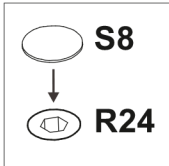
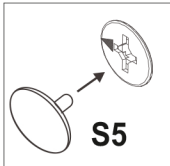
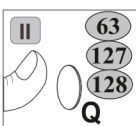
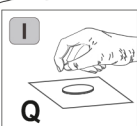

19

H48

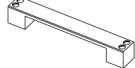

2

M5



M4x25

4

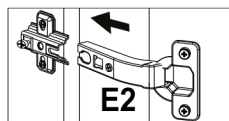

E2

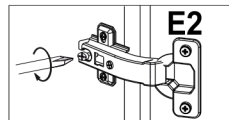

E2

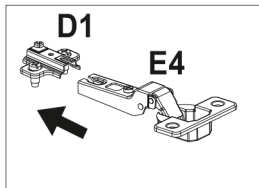

D1

E4

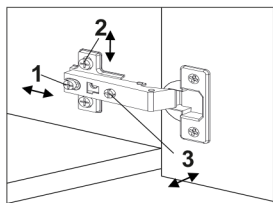
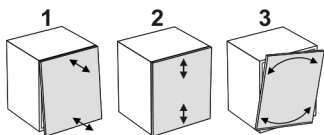
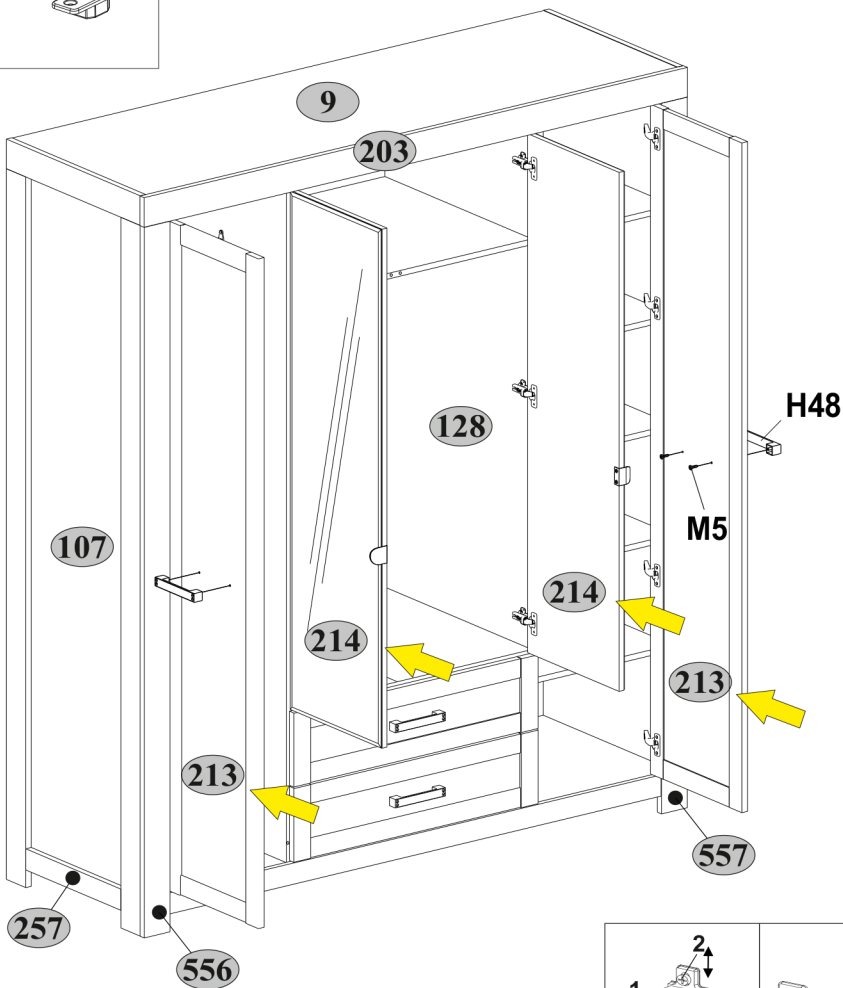

20

